

PRODUCT SPECIFICATION SHEET

TL11

Grab Rail

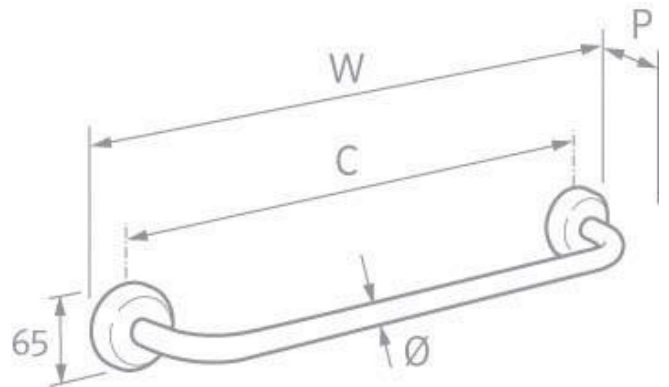

DIMENSIONS (MM)	W : 665	D : 65	P : 85
MATERIALS:	Brass, Zinc diecast		
SPECIAL FEATURES:	Contemporary Design, Service Condition 2 Chromium Plating BS EN 12540:2000		
CLEANING:	Clean with a soft cloth and mild detergent. No abrasives to be used		
GUARANTEE:	20 Year Manufacturing Guarantee		